

# DATA SHEET

**74F74**

Dual D-type flip-flop

Product specification  
Supersedes data of 1990 Oct 23  
IC15 Data Handbook

1996 Mar 12

# Dual D-type flip-flop

# 74F74

## FEATURE

- Industrial temperature range available (−40°C to +85°C)

## DESCRIPTION

The 74F74 is a dual positive edge-triggered D-type flip-flop featuring individual data, clock, set, and reset inputs; also true and complementary outputs. Set ( $\overline{SD}$ ) and reset ( $\overline{RD}$ ) are asynchronous active low inputs and operate independently of the clock input. When set and reset are inactive (high), data at the D input is transferred to the Q and  $\overline{Q}$  outputs on the low-to-high transition of the clock. Data must be stable just one setup time prior to the low-to-high transition of the clock for predictable operation. Clock triggering occurs at a voltage level and is not directly related to the transition time of the positive-going pulse. Following the hold time interval, data at the D input may be changed without affecting the levels of the output.

## PIN CONFIGURATION

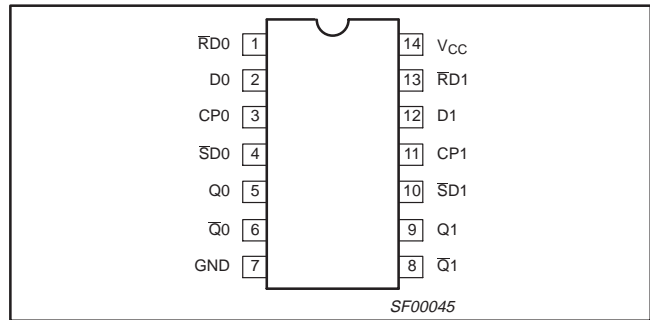

TYPE	TYPICAL $f_{max}$	TYPICAL SUPPLY CURRENT (TOTAL)
74F74	125MHz	11.5mA

## ORDERING INFORMATION

DESCRIPTION	ORDER CODE		PKG. DWG. #
	COMMERCIAL RANGE $V_{CC} = 5V \pm 10\%$ , $T_{amb} = 0^{\circ}C$ to $+70^{\circ}C$	INDUSTRIAL RANGE $V_{CC} = 5V \pm 10\%$ , $T_{amb} = -40^{\circ}C$ to $+85^{\circ}C$	
14-pin plastic DIP	N74F74N	I74F74N	SOT27-1
14-pin plastic SO	N74F74D	I74F74D	SOT108-1

## INPUT AND OUTPUT LOADING AND FAN OUT TABLE

PINS	DESCRIPTION	74F (U.L.) HIGH/LOW	LOAD VALUE HIGH/LOW
D0, D1	Data inputs	1.0/1.0	20 $\mu$ A/0.6mA
CP0, CP1	Clock inputs (active rising edge)	1.0/1.0	20 $\mu$ A/0.6mA
$\overline{SD}$ 0, $\overline{SD}$ 1	Set inputs (active low)	1.0/3.0	20 $\mu$ A/1.8mA
$\overline{RD}$ 0, $\overline{RD}$ 1	Reset inputs (active low)	1.0/3.0	20 $\mu$ A/1.8mA
Q0, Q1, $\overline{Q}$ 0, $\overline{Q}$ 1	Data outputs	50/33	1.0mA/20mA

**NOTE:** One (1.0) FAST unit load is defined as: 20 $\mu$ A in the high state and 0.6mA in the low state.

## LOGIC SYMBOL

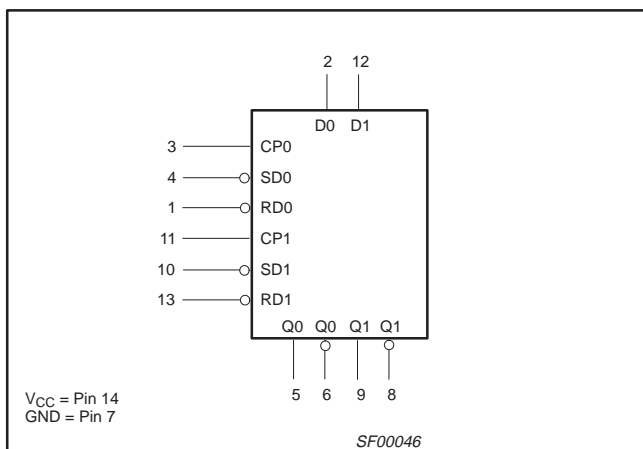

## IEC/IEEE SYMBOL

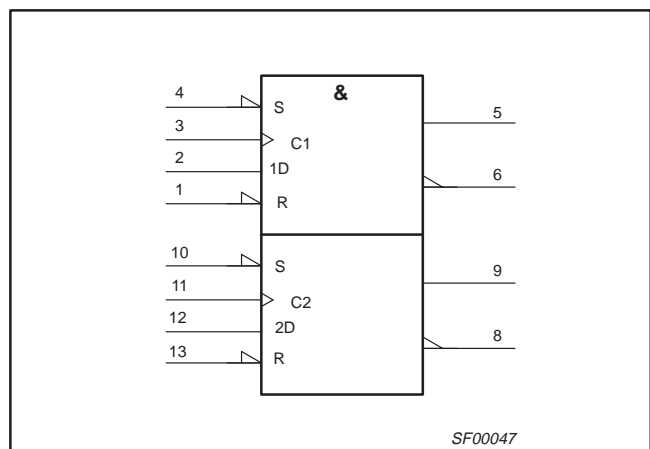

# Dual D-type flip-flop

74F74

## LOGIC DIAGRAM

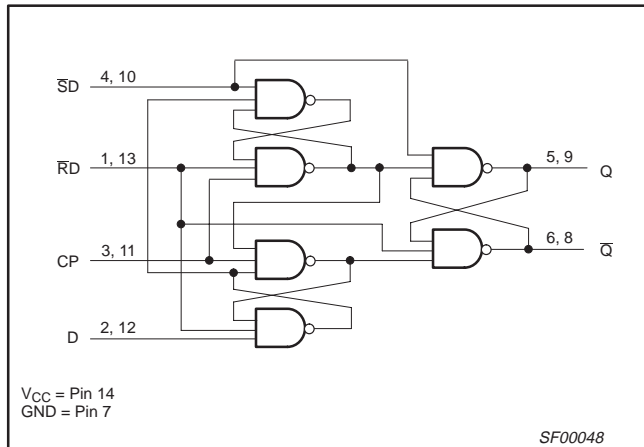

## FUNCTION TABLE

INPUTS				OUTPUTS		OPERATING MODE
SD	RD	CP	D	Q	Q̄	
L	H	X	X	H	L	Asynchronous set
H	L	X	X	L	H	Asynchronous reset
L	L	X	X	H	H	Undetermined*
H	H	↑	h	H	L	Load "1"
H	H	↑	l	L	H	Load "0"
H	H	⊕	X	NC	NC	Hold

### NOTES:

- H = High voltage level
- h = High voltage level one setup time prior to low-to-high clock transition
- L = Low voltage level
- l = Low voltage level one setup time prior to low-to-high clock transition
- NC = No change from the previous setup
- X = Don't care
- ↑ = Low-to-high clock transition
- ⊕ = Not low-to-high clock transition
- \* = This setup is unstable and will change when either set or reset return to the high level.

## ABSOLUTE MAXIMUM RATINGS

(Operation beyond the limit set forth in this table may impair the useful life of the device. Unless otherwise noted these limits are over the operating free air temperature range.)

SYMBOL	PARAMETER	RATING	UNIT
V <sub>CC</sub>	Supply voltage	-0.5 to +7.0	V
V <sub>IN</sub>	Input voltage	-0.5 to +7.0	V
I <sub>IN</sub>	Input current	-30 to +5	mA
V <sub>OUT</sub>	Voltage applied to output in high output state	-0.5 to V <sub>CC</sub>	V
I <sub>OUT</sub>	Current applied to output in low output state	40	mA
T <sub>amb</sub>	Operating free air temperature range	Commercial range	0 to +70 °C
		Industrial range	-40 to +85 °C
T <sub>stg</sub>	Storage temperature range	-65 to +150	°C

## RECOMMENDED OPERATING CONDITIONS

SYMBOL	PARAMETER	LIMITS			UNIT
		MIN	NOM	MAX	
V <sub>CC</sub>	Supply voltage	4.5	5.0	5.5	V
V <sub>IH</sub>	High-level input voltage	2.0			V
V <sub>IL</sub>	Low-level input voltage			0.8	V
I <sub>Ik</sub>	Input clamp current			-18	mA
I <sub>OH</sub>	High-level output current			-1	mA
I <sub>OL</sub>	Low-level output current			20	mA
T <sub>amb</sub>	Operating free air temperature range	Commercial range	0	+70	°C
		Industrial range	-40	+85	°C

## Dual D-type flip-flop

74F74

## DC ELECTRICAL CHARACTERISTICS

(Over recommended operating free-air temperature range unless otherwise noted.)

SYMBOL	PARAMETER	TEST CONDITIONS <sup>1</sup>		LIMITS			UNIT	
				MIN	TYP <sup>2</sup>	MAX		
V <sub>OH</sub>	High-level output voltage	V <sub>CC</sub> = MIN, V <sub>IL</sub> = MAX, V <sub>IH</sub> = MIN	I <sub>OH</sub> = MAX	±10%V <sub>CC</sub>	2.5		V	
				±5%V <sub>CC</sub>	2.7	3.4	V	
V <sub>OL</sub>	Low-level output voltage	V <sub>CC</sub> = MIN, V <sub>IL</sub> = MAX, V <sub>IH</sub> = MIN	I <sub>OL</sub> = MAX	±10%V <sub>CC</sub>		0.30	0.50	V
				±5%V <sub>CC</sub>		0.30	0.50	V
V <sub>IK</sub>	Input clamp voltage	V <sub>CC</sub> = MIN, I <sub>I</sub> = I <sub>IK</sub>			-0.73	-1.2	V	
I <sub>I</sub>	Input current at maximum input voltage	V <sub>CC</sub> = MAX, V <sub>I</sub> = 7.0V				100	μA	
I <sub>IH</sub>	High-level input current	V <sub>CC</sub> = MAX, V <sub>I</sub> = 2.7V				20	μA	
I <sub>IL</sub>	Low-level input current	Dn, CPn	V <sub>CC</sub> = MAX, V <sub>I</sub> = 0.5V			-0.6	mA	
		$\overline{S}Dn, \overline{R}Dn$	V <sub>CC</sub> = MAX, V <sub>I</sub> = 0.5V			-1.8	mA	
I <sub>OS</sub>	Short-circuit output current <sup>3</sup>	V <sub>CC</sub> = MAX			-60	-150	mA	
I <sub>CC</sub>	Supply current (total) <sup>4</sup>	V <sub>CC</sub> = MAX			11.5	16	mA	

## NOTES:

- For conditions shown as MIN or MAX, use the appropriate value specified under recommended operating conditions for the applicable type.
- All typical values are at V<sub>CC</sub> = 5V, T<sub>amb</sub> = 25°C.
- Not more than one output should be shorted at a time. For testing I<sub>OS</sub>, the use of high-speed test apparatus and/or sample-and-hold techniques are preferable in order to minimize internal heating and more accurately reflect operational values. Otherwise, prolonged shorting of a high output may raise the chip temperature well above normal and thereby cause invalid readings in other parameter tests. In any sequence of parameter tests, I<sub>OS</sub> tests should be performed last.
- Measure I<sub>CC</sub> with the clock input grounded and all outputs open, then with Q and  $\overline{Q}$  outputs high in turn.

## AC ELECTRICAL CHARACTERISTICS

SYMBOL	PARAMETER	TEST CONDITION	LIMITS						UNIT	
			V <sub>CC</sub> = +5.0V T <sub>amb</sub> = +25°C C <sub>L</sub> = 50pF, R <sub>L</sub> = 500Ω			V <sub>CC</sub> = +5.0V ± 10% T <sub>amb</sub> = 0°C to +70°C C <sub>L</sub> = 50pF, R <sub>L</sub> = 500Ω		V <sub>CC</sub> = +5.0V ± 10% T <sub>amb</sub> = -40°C to +85°C C <sub>L</sub> = 50pF, R <sub>L</sub> = 500Ω		
			MIN	TYP	MAX	MIN	MAX	MIN		MAX
f <sub>max</sub>	Maximum clock frequency	Waveform 1	100	125		100		90		MHz
t <sub>PLH</sub> t <sub>PHL</sub>	Propagation delay CPn to Qn or $\overline{Q}n$	Waveform 1	3.8 4.4	5.3 6.2	6.8 8.0	3.8 4.4	7.8 9.2	3.8 4.4	8.5 9.2	ns
t <sub>PLH</sub> t <sub>PHL</sub>	Propagation delay $\overline{S}Dn, \overline{R}Dn$ to Qn or $\overline{Q}n$	Waveform 2	3.2 3.5	4.6 7.0	6.1 9.0	3.2 3.5	7.1 10.5	3.2 2.5	7.5 10.5	ns

## AC SETUP REQUIREMENTS

SYMBOL	PARAMETER	TEST CONDITION	LIMITS						UNIT	
			V <sub>CC</sub> = +5.0V T <sub>amb</sub> = +25°C C <sub>L</sub> = 50pF, R <sub>L</sub> = 500Ω			V <sub>CC</sub> = +5.0V ± 10% T <sub>amb</sub> = 0°C to +70°C C <sub>L</sub> = 50pF, R <sub>L</sub> = 500Ω		V <sub>CC</sub> = +5.0V ± 10% T <sub>amb</sub> = -40°C to +85°C C <sub>L</sub> = 50pF, R <sub>L</sub> = 500Ω		
			MIN	TYP	MAX	MIN	MAX	MIN		MAX
t <sub>su</sub> (H) t <sub>su</sub> (L)	Setup time, high or low Dn to CPn	Waveform 1	2.0 3.0			2.0 3.0		2.0 3.0		ns
t <sub>h</sub> (H) t <sub>h</sub> (L)	Hold time, high or low Dn to CPn	Waveform 1	1.0 1.0			1.0 1.0		1.0 1.0		ns
t <sub>w</sub> (H) t <sub>w</sub> (L)	CPn pulse width, high or low	Waveform 1	4.0 5.0			4.0 5.0		4.0 5.0		ns
t <sub>w</sub> (L)	$\overline{S}Dn, \overline{R}Dn$ pulse width, low	Waveform 2	4.0			4.0		4.0		ns
t <sub>rec</sub>	Recovery time $\overline{S}Dn, \overline{R}Dn$ to CPn	Waveform 3	2.0			2.0		2.0		ns

# Dual D-type flip-flop

74F74

## AC WAVEFORMS

For all waveforms,  $V_M = 1.5V$ .

The shaded areas indicate when the input is permitted to change for predictable output performance.

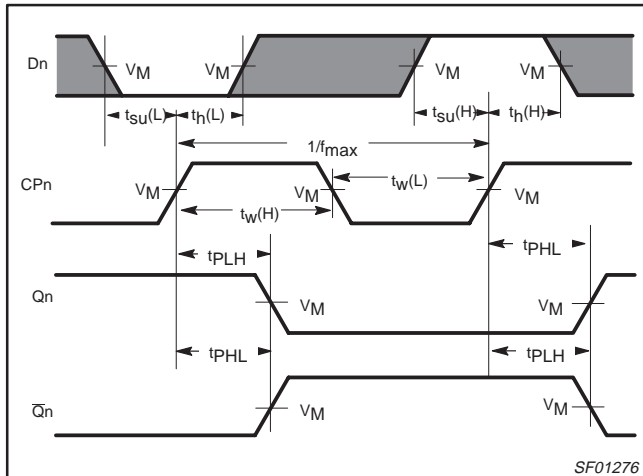

Waveform 1. Propagation delay for data to output, data setup time and hold times, and clock width, and maximum clock frequency

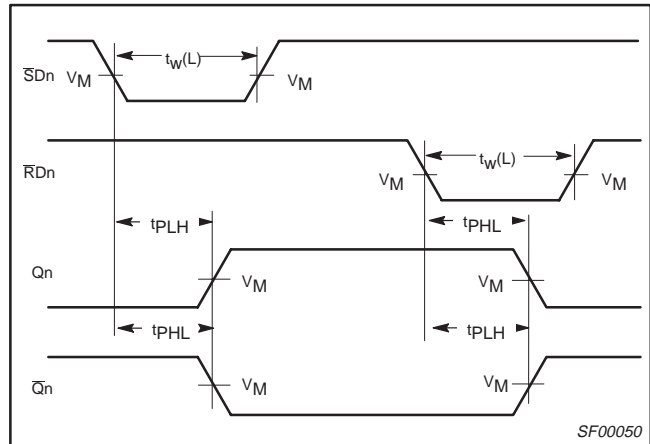

Waveform 2. Propagation delay for set and reset to output, set and reset pulse width

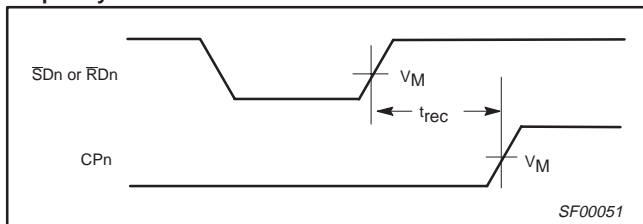

Waveform 3. Recovery time for set or reset to clock

## TEST CIRCUIT AND WAVEFORMS

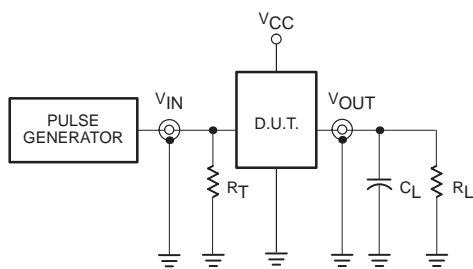

Test Circuit for Totem-Pole Outputs

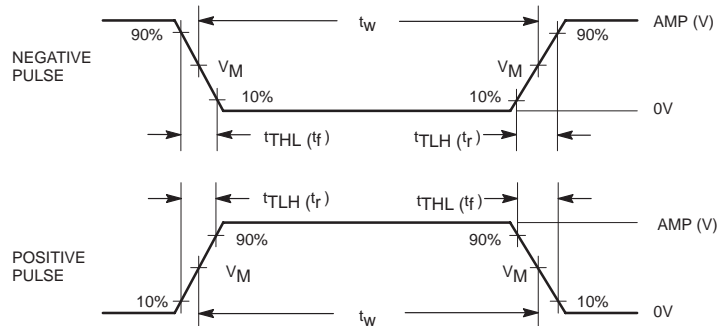

### Input Pulse Definition

family	INPUT PULSE REQUIREMENTS					
	amplitude	$V_M$	rep. rate	$t_w$	$t_{TLH}$	$t_{THL}$
74F	3.0V	1.5V	1MHz	500ns	2.5ns	2.5ns

SF00006

# Dual D-type flip-flop

74F74

DIP14: plastic dual in-line package; 14 leads (300 mil)

SOT27-1



**DIMENSIONS (inch dimensions are derived from the original mm dimensions)**

UNIT	A max.	A <sub>1</sub> min.	A <sub>2</sub> max.	b	b <sub>1</sub>	c	D <sup>(1)</sup>	E <sup>(1)</sup>	e	e <sub>1</sub>	L	M <sub>E</sub>	M <sub>H</sub>	w	Z <sup>(1)</sup> max.
mm	4.2	0.51	3.2	1.73 1.13	0.53 0.38	0.36 0.23	19.50 18.55	6.48 6.20	2.54	7.62	3.60 3.05	8.25 7.80	10.0 8.3	0.254	2.2
inches	0.17	0.020	0.13	0.068 0.044	0.021 0.015	0.014 0.009	0.77 0.73	0.26 0.24	0.10	0.30	0.14 0.12	0.32 0.31	0.39 0.33	0.01	0.087

**Note**

1. Plastic or metal protrusions of 0.25 mm maximum per side are not included.

OUTLINE VERSION	REFERENCES			EUROPEAN PROJECTION	ISSUE DATE
	IEC	JEDEC	EIAJ		
SOT27-1	050G04	MO-001AA			92-11-17 95-03-11

# Dual D-type flip-flop

74F74

SO14: plastic small outline package; 14 leads; body width 3.9 mm

SOT108-1

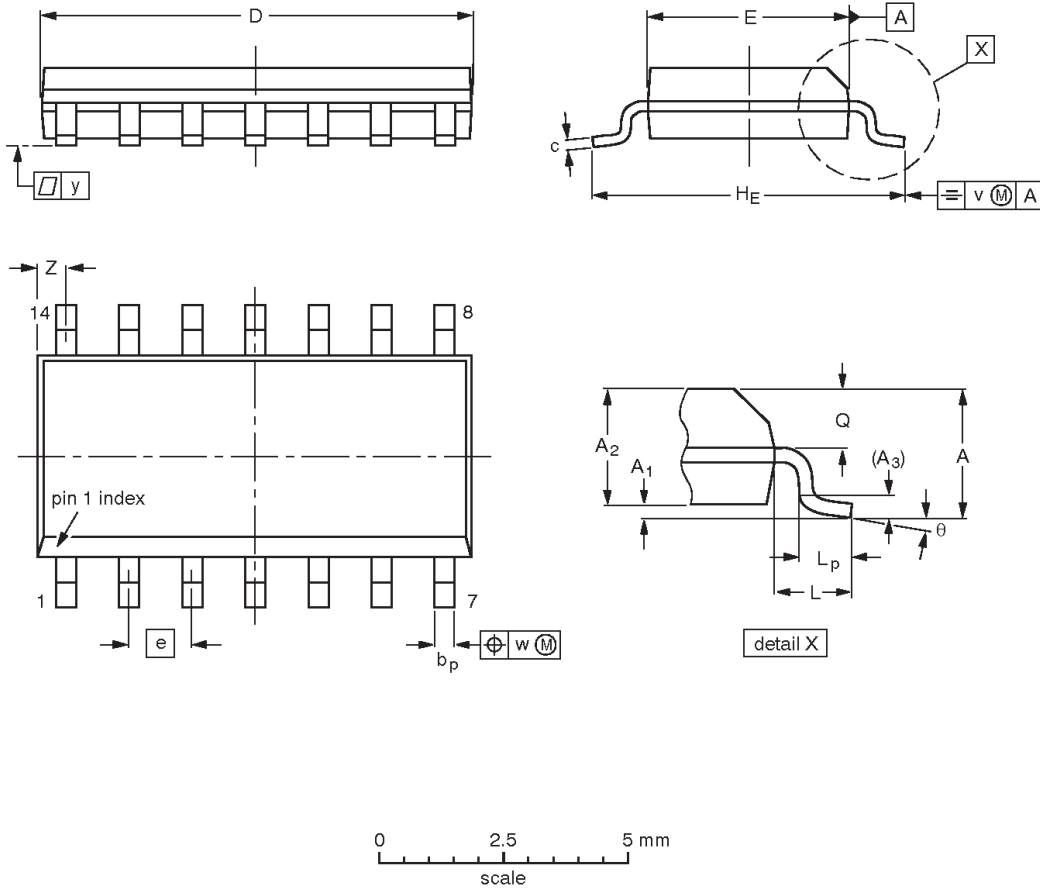

**DIMENSIONS (inch dimensions are derived from the original mm dimensions)**

UNIT	A max.	A <sub>1</sub>	A <sub>2</sub>	A <sub>3</sub>	b <sub>p</sub>	c	D <sup>(1)</sup>	E <sup>(1)</sup>	e	H <sub>E</sub>	L	L <sub>p</sub>	Q	v	w	y	Z <sup>(1)</sup>	θ
mm	1.75	0.25 0.10	1.45 1.25	0.25	0.49 0.36	0.25 0.19	8.75 8.55	4.0 3.8	1.27	6.2 5.8	1.05	1.0 0.4	0.7 0.6	0.25	0.25	0.1	0.7 0.3	8° 0°
inches	0.069	0.010 0.004	0.057 0.049	0.01	0.019 0.014	0.0100 0.0075	0.35 0.34	0.16 0.15	0.050	0.244 0.228	0.041	0.039 0.016	0.028 0.024	0.01	0.01	0.004	0.028 0.012	

**Note**

1. Plastic or metal protrusions of 0.15 mm maximum per side are not included.

OUTLINE VERSION	REFERENCES			EUROPEAN PROJECTION	ISSUE DATE
	IEC	JEDEC	EIAJ		
SOT108-1	076E06S	MS-012AB			95-01-23 97-05-22

## Dual D-type flip-flop

74F74

## Data sheet status

Data sheet status	Product status	Definition [1]
Objective specification	Development	This data sheet contains the design target or goal specifications for product development. Specification may change in any manner without notice.
Preliminary specification	Qualification	This data sheet contains preliminary data, and supplementary data will be published at a later date. Philips Semiconductors reserves the right to make changes at any time without notice in order to improve design and supply the best possible product.
Product specification	Production	This data sheet contains final specifications. Philips Semiconductors reserves the right to make changes at any time without notice in order to improve design and supply the best possible product.

[1] Please consult the most recently issued datasheet before initiating or completing a design.

## Definitions

**Short-form specification** — The data in a short-form specification is extracted from a full data sheet with the same type number and title. For detailed information see the relevant data sheet or data handbook.

**Limiting values definition** — Limiting values given are in accordance with the Absolute Maximum Rating System (IEC 134). Stress above one or more of the limiting values may cause permanent damage to the device. These are stress ratings only and operation of the device at these or at any other conditions above those given in the Characteristics sections of the specification is not implied. Exposure to limiting values for extended periods may affect device reliability.

**Application information** — Applications that are described herein for any of these products are for illustrative purposes only. Philips Semiconductors make no representation or warranty that such applications will be suitable for the specified use without further testing or modification.

## Disclaimers

**Life support** — These products are not designed for use in life support appliances, devices or systems where malfunction of these products can reasonably be expected to result in personal injury. Philips Semiconductors customers using or selling these products for use in such applications do so at their own risk and agree to fully indemnify Philips Semiconductors for any damages resulting from such application.

**Right to make changes** — Philips Semiconductors reserves the right to make changes, without notice, in the products, including circuits, standard cells, and/or software, described or contained herein in order to improve design and/or performance. Philips Semiconductors assumes no responsibility or liability for the use of any of these products, conveys no license or title under any patent, copyright, or mask work right to these products, and makes no representations or warranties that these products are free from patent, copyright, or mask work right infringement, unless otherwise specified.

Philips Semiconductors  
811 East Arques Avenue  
P.O. Box 3409  
Sunnyvale, California 94088-3409  
Telephone 800-234-7381

© Copyright Philips Electronics North America Corporation 1998  
All rights reserved. Printed in U.S.A.

print code

Date of release: 10-98

Document order number:

9397-750-05066

*Let's make things better.*